



MALVINA EUROPE SARL

CAPITAL VARIABLE DE 15 246 Euros • C.E. FR 784 376 783 78

R.C.S Saint-Gaudens 437 678 378 • SIRET 437 678 378 00013



HOT TUB POLYURETHANE





Hot tub

POLYURETHANE

health, beauty, peace of mind



Bottle holder



LED light



Scoop and poker



Paddle



Tent cover



Wooden cover

Specifications

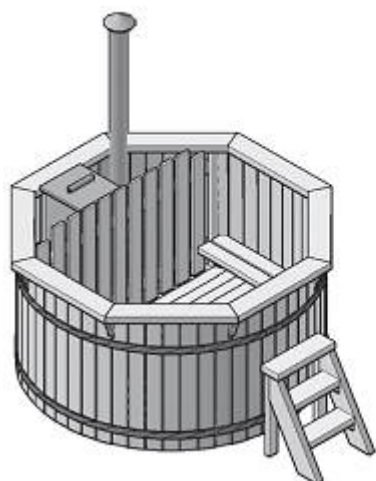

Diameter, m	1,5	1,9	2,2
Capacity, l	1600	2550	3420
Weight, kg (empty hot tub)	250	350	450
Group of people	4-6	6-8	8-10

HOT TUB STANDARD SET

- Wooden hot tub with inside polyurethane painting
- Stainless steel built-in heater with a chimney
- Stainless steel hoops
- Safety fence
- Benches
- Outlet valve for water hose connection
- Stairs „3 steps“

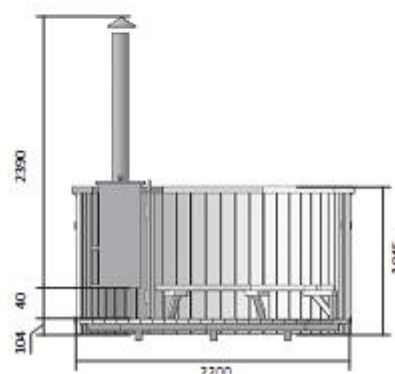
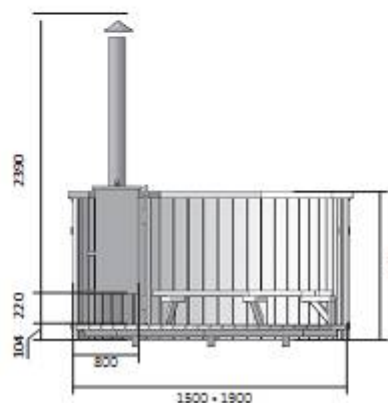
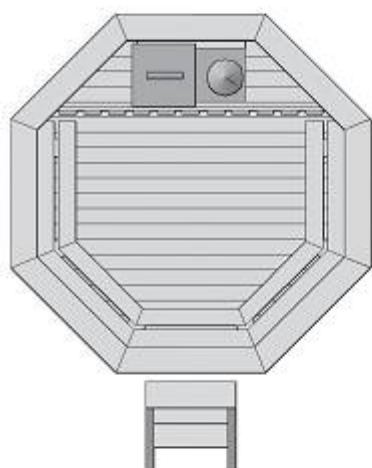
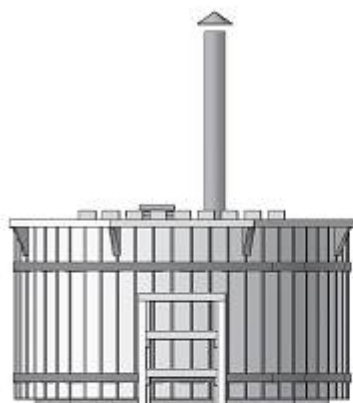

Water heaters

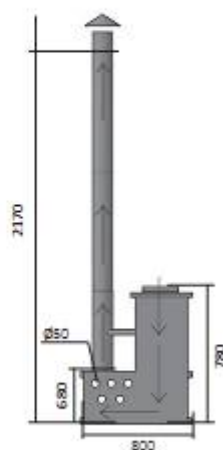

For ϕ 1500/1900 diameter hot tub

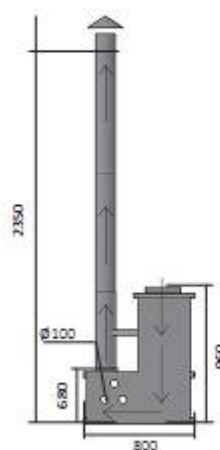

For ϕ 2200 diameter hot tub

INSIDE WOOD BURNING HEATERS MADE OF STAINLESS STEEL.

Stainless steel metal 304 is the most widely used steel. Provides good resistance in moderately acidic solutions.

Type of wood



SPRUCE

The spruce is of Nordic species. It is light coloured, nearly white. Thin and regular texture. Suitable for painting and flexible. Spruce tubs are outstanding for being waterproof and durable.

Inside coating



POLYURETHANE

The inside surface of the hot tub is covered chemically with a two-component (isocyanate A and polyol B) coating maintaining unique adhesive and elastic properties. The coating hardens within 3-9 seconds and the surface is ready for use in 2-3 minutes, but all strengthening properties of the coating are achieved within 24 hours.

Polyurethane layer is flexible and adjust the hot tub basis at any conditions. If small cracks occur in the hot tub wooden basis the internal polyurethane protective coating remains solid and intact.

Polyurethane coating is non-slip, waterproof, mold resistant, no color change and crumbling, it is particularly resistant to abrasion, critical temperature changes or direct sunlight. Due to resistance of petroleum products and chemicals it is easy to clean and disinfect.

Accessories



TENT COVER

Tent cover for hot tub helps to keep water clean for a longer time.



WOODEN COVER

Wooden cover for hot tub helps to keep water clean for a longer time. 1,5m diameter covers consists of 2 parts, 1,9m diameter and 2,2m diameter covers consists of 3 parts.



STAIRS „2 STEPS“

Height – 65 cm;
width – 50 cm.



BOTTLE HOLDER

Bottle holder for 5 bottles available in either larch or spruce.



MIXING PADDLE

Length of the shaft – 177 cm, width – 5 cm; Width of the blade – 14 cm; thickness – 2,5 cm



LED LIGHT

LED waterproof light with automatic color change. The lights are powered by 4 x AAA batteries (not included). Size: 11cm x 4,5cm. Price for 2 PCS.



SCOOP & POKER

A scoop and a poker with wooden handles for cleaning and maintenance of the hot tub heater. Height – 82 cm; Size of the shovel – 12x15 cm.



IMPREGNATION

Impregnation is produced from natural ingredients. It accentuates the texture of wood, protects wood from side effects of the atmosphere and UV rays.

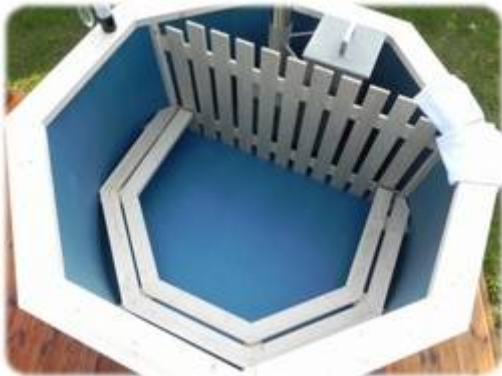

Transportation



ASSEMBLED HOT TUBS



Usage



After purchasing our open air bath first of all you should fill it with water. When preparing for bathing, the tub should be filled-in with water about 10 cm below the top, taking into account the number of people that are going to use it. Before heating the water, make sure that the heater is submerged in water about 5- 10 cm below the footing of the chimney. Firewood or briquettes can

be used for heating; water is heated to 40°C in 2-4 hours depending on the material used for heating and air temperature.

Maintenance



At least once a year the functioning tub must be impregnated as it gives more durability. After usage the tub and water inside must be cleaned. If there is no need to change the water just remove impurities with a gripping device. If the hot tub is kept outside it should be drained before winter months come. It can be drained through a valve at the bottom of the tub for easy water disposal. Water also can be emptied by using a pump. For hot tub cleaning and maintenance the water pool maintenance equipment can be used. Water must be removed only for cleaning reasons or when changing the water. In the

cold period of the year the tub should be kept empty as the ice can cause damage. In winter there is sufficient humidity in the air which provides protection against desiccation. However, if the wood has slightly dried, the constriction rings must be tightened before pouring water. To avoid pollution, the tubs that are not used in the open air should be kept covered.





MALVINA SYSTEMS



www.malvina.fr



MALVINA EUROPE SARL

55, avenue Foch, 31110 – Bagnères de Luchon (France)

E-mail : malvina@malvina.fr - chalets@malvina.fr

Web : www.chaleurverte.malvina.fr - www.malvina-europe.com

Bureau : 33 (0) 561 794 699 - Mobile : 33 (0) 688 881 532

Skype : [malvinaeurope](https://www.skype.com/name/malvinaeurope)



chalets@malvina.fr