



# MALVINA EUROPE SARL

CAPITAL VARIABLE DE 15 246 Euros • C.E. FR 784 376 783 78

R.C.S Saint-Gaudens 437 678 378 • SIRET 437 678 378 00013

CODE APE : 4120 A



pellets@malvina.fr  
malvina@malvina.fr









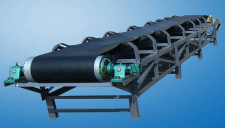

**MALVINA SYSTEMS** EQUIPMENT SARL

+33 (0) 688 881 532  
+33 (0) 561 794 699

## 1. CONSISTING: LIGNE DE PRODUCTIONS DE PELLETS DE BIOMASSES - 2,5-3,0/tonnes/heure - LISTE ÉQUIPEMENTS

<b>1.1 Equipments</b>	<b>166 840,00 €</b>
1.1.3. Raw material receiving&pre-cleaning&drying process	72 150,00 €
1.1.4. Pelleting Process	70 995,00 €
1.1.5. Cooling&Sifting&Packing Process - Processus refroidissement et tamisage et emballage)	23 695,00 €
<b>1.2. Electric system</b>	<b>21 000,00 €</b>
1.2.1 Centralized control cabinet	
1.2.2 On site control cabinet	
<b>1.3. On-site materials</b>	<b>21 000,00 €</b>
<b>1.3.1 Outils d'installation, machine découpe, machine soudage électrique, compresseur air.....</b>	
1.3.1 Installation tools, cutting machine, electric welding machine, air compressor and so on.	
1.3.2 Frame and support material, such as channel steel, angle iron, welding electrode and so on	
1.3.3 Electric wire and cables - <b>Fil électrique et câbles</b>	
1.3.4 Paint	
<b>1.4. Design fee and training fee - 1.4. Frais de conception et frais de formation</b>	<b>FREE</b>
<b>1.5. Guiding installation and testing - 1.5. Guide d'installation et de test</b>	<b>BY BUYER</b>
<b>Inclus, frais billet d'avion, salaire 2 ingénieurs pour l'installation (durée maxi 30 jours), le conseil et l'hébergement à charge de l'acheteur.</b>	
Including the airticket fee and salary for two engineers when installation (installation time not over 30 days), the board and lodging by buyer.	
<b>TOTAL EXW PRICE</b>	<b>208 840,00 €</b>
<b>TOTAL CFR PRICE</b>	<b>218 840,00 €</b>

2. ITEMS									
2,5-3,00 Tonnes/heure PH PINE SAWDUST & OLIVE POMACE PELLET PRODUCTION LINE---EQUIPMENT LIST									
2.2. Condition:			Quotation valid within 1 month. The voltage is 3phases, 380V, 50HZ.						
2.3. Loading Port:			ASIA PORT						
2.4. Payment:			50% deposit by TT after signed contract, 50% by TT or LC before delivery.						
2.5. Delivery time:			40-60days after received the 50% deposit.						
2,5-3,00 Tonnes/heure PH PINE SAWDUST&OLIVE POMACE PELLET PRODUCTION LINE---EQUIPMENT LIST									
No.	Picture	Item	Type&Size	Qty	Power (kw)		Price(€uros)		Remark
					Unit	Total	Unit	Total	
<b>1.Raw material receiving&amp;pre-cleaning&amp;drying process</b>									
101		Convoyeur	7M	1	2,20	2,20			Avec l'alimentation de conversion de fréquence, utilisant la ceinture d'épaisseur de haute résistance de 8MM.
102		Four à chaleur	HS-400	1					Avec pare-feu à l'intérieur, brûler le bois, le charbon, les granulés de bois et ainsi de suite pour fournir l'air chaud. Corps principal: plaques en acier Mn 18MM. Avec brique réfractaire à l'intérieur
103		Pré-nettoyage	TCY63	1	2,20	2,20			Q235 3mm steel plates, remove the big wood block
104		Dust collector system	TBLMFa12	1	1,10	1,10			Remove the dust
105		Input screw conveyor		1	2,20	2,20			Force the wet sawdust into drum dryer

No.	Picture	Item	Type&Size	Qty	Power (kw)		Price(€uros)		Remark
					Unit	Total	Unit	Total	
106		<b>Tambour de séchage</b>	Φ1.5*9M	1	6,00	6,00			Avec un deuxième système de séchage et un équipement antidéflagrant. Le dryer principal de tambour emploiera l'acier de Mn d'épaisseur de 18MM. L'extérieur recouvert de panneau d'isolation thermique.1.Il est fait de corps rotatif, plaque de levage, engrenage, équipement de soutien et les phoques et autres composants. 2. Haute production, fonctionnement continu. Faible dysfonctionnement et performances fiables et stables, faible charge de maintenance. Large gamme d'application, nettoyage facile. 3. Avec le deuxième système de séchage, peut assurer la capacité et l'effet de séchage. Les portes coupe-feu et les grilles de feu utilisent toutes de la fonte. Dans le poêle chaud, va mettre en place un pare-feu, afin de prévenir le feu dans le tambour. 4.Il y a des indicateurs de température d'entrée et de sortie dans l'armoire de commande électrique.
107		Secoding drying system		1					
108		Cyclone	Φ800X2	1set					
109		Airlock	GFZ25	1	2,20	2,20			
110		Draught fan	9-16-No.5.6A	1	22,00	22,00			
		Water box		1					Make on site
		<b>Subtotal</b>				<b>37,90</b>		<b>0,00</b>	



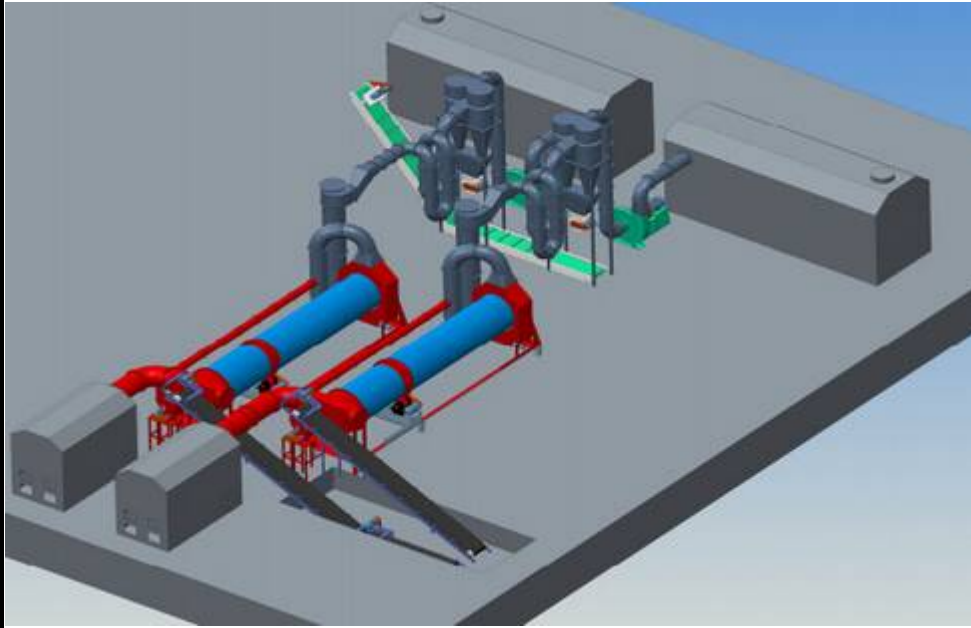

No.	Picture	Item	Type&Size	Qty	Power (kw)		Price(€uros)		Remark
					Unit	Total	Unit	Total	



**2. Pelleting Process**



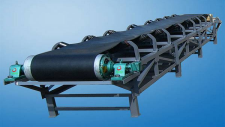







No.	Picture	Item	Type&Size	Qty	Power (kw)		Price(€uros)		Remark
					Unit	Total	Unit	Total	
206		Fan	4-72-No5A	1	2,20	4,40			National standard,dynamic balancing testing
207		Cyclone	Φ800	1					Up: 4MM Q235 plaque d'acier, vers le bas: 3MM Q235 plaque d'acier, tous les standards asiatiques.
208		Box		1					
209		Belt conveyor		1	2,20	2,20			Granulés de bois de sortie, relie deux ensembles bois moulin de granule, en utilisant la ceinture d'épaisseur de haute résistance 8MM
		Grease pump		1					
		<b>Subtotal</b>				<b>238,60</b>		<b>0,00</b>	

No.	Picture	Item	Type&Size	Qty	Power (kw)		Price(€uros)		Remark
					Unit	Total	Unit	Total	
									
									
									

### 3.Cooling&Sifting&Packing Process

301		Undulant walled belt conveyor	BC-007	1	3,00	3,00			With Frequency conversion,PVC high strength belt,high temperature resistance. Prevent wood pellets slip.
-----	--	-------------------------------	--------	---	------	------	--	--	--

No.	Picture	Item	Type&Size	Qty	Power (kw)		Price(€uros)		Remark
					Unit	Total	Unit	Total	
302		Screener		1	1,50	1,50			Tamiser les pellets, enlever la poussière. Plaque d'acier 3MM Q235, standard chinois. Taux de séparation d'impurity≥99% Corps de moteur: Q235 4mm plaque d'acier, spécification de cylindre de tamis: Ø630X870, lame de vis de cylindre de tamis inwall, réducteur de roue de cycloidal goupille, porte à ouverture rapide, roue de chaîne, transmission de chian, roulement d'auto-alignement d'UCF .
303		Cooler bin	N3	1	2,20	2,20			Avec le chargeur de sas, plateforme d'acier du refroidissement Q235.3MM uniforme, norme asiatique.
304				2					
305		Fan	4-72-No5A	1	5,50	5,50			National standard,dynamic balancing testing
306		Cyclone	Φ1000	1					Pour la collecte de la poussière. Up: 4MM Q235 plaque d'acier, vers le bas: 3MM Q235 plaque d'acier, tous les standards chinois.



No.	Picture	Item	Type&Size	Qty	Power (kw)		Price(€uros)		Remark
					Unit	Total	Unit	Total	
306	Auto Packaging scale(Échelle d'emballage automatique)		SDBY-1	1	1,10	1,10			Spécification d'emballage 20kg-40kg, précision d'emballage ± 20g, comptage automatique des ordinateurs, pesée en continu, compensation de poids automatique, contrôle de panneau intelligent, porte de déchargement automatique à verrouillage. (Spécification d'emballage 20kg-40kg, précision d'emballage ± 20g, comptage automatique d'ordinateur, pesant en continu, compensation automatique de poids,
307	Sewing conveyor(Convoyeur à coudre)		TFKB40	1	1,10	1,10			
		<b>Total</b>				<b>277,60</b>		<b>0,00</b>	

Conditions de livraison : [Franco destination](#)

### Conditions de paiement pour la France et CE

Caractéristiques de la marchandise :

**MALVINA EUROPE SARL**

**Conditions de paiement par virement: 1er acompte 50% à la commande >> Euro**  
**2ème acompte 45% avant le départ du camion > Euro, le solde 5% à la livraison**  
**après contrôle des palettes numérotées kit/bois chargées sur 2 camions >>**

**COORDONNÉES BANCAIRES POUR VIREMENT SWIFT**

BANQUE CREDIT AGRICOLE MUTUEL CAISSE REGIONALE DE TOULOUSE ET DU MIDI TOULOUSAIN

CODE BANQUE : **13106** Code Guichet **00500** N° DE COMPTE : **1012 MALVINA EUROPE SARL**

**BANQUE IDENTIFICATION CODE (BIC) : AGRIFRPP831**

**INTERNATIONAL BANKING ACCOUNT NUMBER (IBAN) : FR76 1310 6 MALVINA SYSTEMS 3**

**RÉCLAMATIONS** : seules les réclamations formulées sous sept jours date de déchargement des camions seront prises en considération

No.	Picture	Item	Type&Size	Qty	Power (kw)		Price(€uros)		Remark
					Unit	Total	Unit	Total	





No.	Picture	Item	Type&Size	Qty	Power (kw)		Price(€uros)		Remark
					Unit	Total	Unit	Total	

**Feed Pellet mill**  
 7 years experience in feed grain production engineering

**MALVINA SYSTEMS** EQUIPMENT SARL +33 (0) 688 881 532  
 +33 (0) 561 794 699

**MZLH 420 MZLH 508 Wood Pellet Mill**  
 Professional manufacturer of biomass pellet production line

[www.malvina-europe.com](http://www.malvina-europe.com)